 Europäisches Patentamt
 European Patent Office
 Office européen des brevets



⑪ Publication number : **0 595 549 A2**

⑫ **EUROPEAN PATENT APPLICATION**

⑲ Application number : 93308393.3

⑤① Int. Cl.⁵ : **H04Q 9/00, G06K 19/00**

⑳ Date of filing : 21.10.93

③① Priority : 26.10.92 GB 9222460

④③ Date of publication of application :
04.05.94 Bulletin 94/18

⑧④ Designated Contracting States :
DE FR GB IT SE

⑦① Applicant : **HUGHES MICROELECTRONICS
EUROPA LIMITED**
Queensway Industrial Estate
Glenrothes Fife KY7 5PY Scotland (GB)

⑦② Inventor : **Bradley, Laurence David**
15 Kentwell Close Rushmere
Ipswich IP4 5BQ (GB)
Inventor : **Deagle, Edwin**
Camberley Laguna
Niguel California 92677 (US)
Inventor : **Glover, Stephen**
7 Park Lane
Glenrothes Fife Scotland (GB)
Inventor : **Harris, Susan**
146 High Street Burntisland
Fife Scotland (GB)

⑦④ Representative : **Colgan, Stephen James**
CARPMAELS & RANSFORD 43 Bloomsbury
Square
London WC1A 2RA (GB)

⑤④ Radio frequency baggage tags.

⑤⑦ A radio frequency identification transponder tag (20) is built on a thin flexible substrate (30) and attached to an airline baggage identification label (10). The RF transponder tag (20) is electrically programmable, physically flexible and self-adhesive and is compatible with existing labelling systems to allow extra features to be added to such systems. The tag is interrogated by a remote interrogation device and includes a plurality of antenna turns (32) formed on a flexible substrate (30) and a transponder circuit chip (54) having double metal layer contact pads (58,60,70,72) at an intermediate portion thereof bonded to antenna pads (34,36) within the innermost turn (38) of the antenna by means of electrically conductive adhesive (80) that is contained and confined between areas of structural adhesive (86) that also interconnect the transponder chip (54) with the substrate (30).

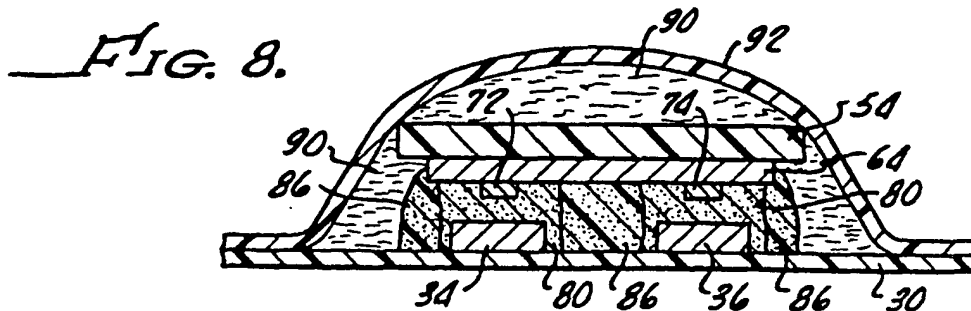

EP 0 595 549 A2

BACKGROUND OF THE INVENTION

1. Field of the Invention

The present invention relates to radio frequency identification tags for airline baggage and similar articles and more particularly concerns incorporation of such an identification tag into a standard baggage identification label.

2. Description of Related Art

It has been the practice for some time to identify personal luggage transported by common carrier, such as airlines, by use of flexible self-adhering paper label strips which encircle a luggage handle and are secured by self-adhesive end portions of the strip. The identification labels commonly are color coded and imprinted with various identification of carrier, destination and other indicia to facilitate sorting, routing and other baggage handling operations. Such identification labels frequently will also include optical bar codes that enable machine reading by optical bar code readers. The optical bar code reader enables machine or automatic identification routing and handling that allow luggage processing to be carried out at higher speed and with fewer errors. Nevertheless optical systems suffer from several disadvantages. Optical readers and bar codes are restricted to line of sight use. The label must be properly oriented to cause the bar code to face the reader. Obstructions that may be positioned between the bar code and optical reader totally disable optical reading. Optical bar code systems are relatively expensive and are capable of storing only a limited amount of data.

Accordingly, it is an object of the present invention to provide for luggage and other object identification and handling by methods and apparatus that minimize or avoid above-mentioned problems.

SUMMARY OF THE INVENTION

In carrying out principles of the present invention, a remotely readable identification tag comprises a flexible substrate, an antenna formed on the substrate, a transponder circuit chip, means for mounting the chip on the substrate and means for electrically connecting the chip to the antenna. According to a preferred feature of the invention, the circuit chip includes electrical contact chip pads on an inner surface portion of the chip and electrically conductive adhesive is interposed between electrical contact antenna pads and the chip pads.

BRIEF DESCRIPTION OF THE DRAWINGS

In the accompanying drawings:

FIG. 1 is a pictorial illustration of a flexible paper

identification label for airline luggage embodying both an optical bar code and a radio frequency transponder tag;

FIG. 2 is a plan view of a typical antenna;

FIG. 3 is a sectional view showing features of the antenna of FIG. 2;

FIG. 4 is a plan view of a transponder circuit chip;

FIG. 5 is a sectional view of the chip;

FIG. 6 illustrates one means of assembly of the chip to the antenna and substrate;

FIG. 7 shows a subsequent step in the assembly;

FIG. 8 shows a still further step in the assembly;

FIG. 9 shows a section of a completed RF tag;

FIGS. 10, 11 and 12 illustrate various alternate antenna pad configurations;

FIG. 13 shows an alternative antenna configuration;

FIG. 14 is a section of the antenna of FIG. 13;

FIGS. 15 and 16 are simplified plan and elevation views of a single identification label; and

FIGS. 17 and 18 illustrate a strip of multiple labels before and after folding.

DESCRIPTION OF THE PREFERRED EMBODIMENTS

As shown in FIG. 1, an elongated luggage identification label, generally indicated at 10, is formed of a thin elongated paper strip 12 that is looped around a luggage handle, part of which is illustrated at 14, so that one end 16 of the paper strip 12 which bears a self-sticking adhesive (not shown) may be adhesively secured to the other end of the paper strip to thereby permanently secure the identification label to the luggage handle. An optical bar code 18 is formed on a readily visible outer portion, such as the outer portion of the end 16 of the label, and additional indicia in the form of printing and/or color coding (not shown) is generally provided on the identification label surface.

The identification label of FIG. 1 embodies still another form of data in the form of an RF (radio frequency) tag, generally indicated at 20, which is suitably secured as by adhesive (as will be described more particularly below) to a surface of one end of the identification label 10. This tag is covered by the label end 16 when the latter is folded over and secured to the other end of the label as shown in FIG. 1. In general the RF tag comprises a thin, flexible transparent substrate 30 bearing a transponder antenna 24 and a transponder circuit chip 26 all encased in a suitable protective covering material.

The transponders described herein are employed in remote magnetically coupled identification systems of the type shown in United States Patent 4,730,188 to Milheiser. The antenna 24 and integrated transponder circuit 26 embody circuit of the nature described in detail in the Milheiser patent. Transponders of this type are made by Hughes Identification Devices,

Inc. and sold as Proxcard™ readers or other types of transponder systems which include various types of readers, scanners and transponders for a variety of identification purposes. Such devices have reading ranges in the order of eight to twelve inches.

As shown in the patent to Milheiser and described in detail therein, and as embodied in the Hughes Identification Devices products, this type of magnetically coupled identification system includes a reader/exciter (not shown) that transmits a radio frequency interrogation signal at a frequency which may be, for example, in the order of about 27 MHz. The transmitted interrogation signal produces a magnetic flux field that is magnetically coupled to the transponder antenna to energize the latter and provide power for the transponder identification and data readout circuitry. The latter carries no battery or other source of stored power. Upon energization of its antenna the transponder identification circuitry assembles an identification code or information signal and other data that are stored in the memory of the transponder. The assembled information signal may contain identification code and other data related to the individual luggage tag. This information signal is fed to the transponder antenna to cause the latter to transmit a return or information signal that is received by the reader/exciter, where it is detected and employed for selected use. Prior transponders, including various combinations of antenna and chip, have been mounted on rigid printed circuit boards, and therefore are unsuitable for attachment to a flexible paper identification label.

According to one embodiment of the present invention, the transponder is formed on a thin, flexible transparent strip of electrically nonconductive material, such as a polyester strip 30 (FIG. 2). A plurality of turns 32 of electrically conductive material are formed as by conventional printed circuit techniques including electroforming, standard etching or screen printing processes on the dielectric polyester substrate. The antenna turns are designated by reference numeral 32. The antenna includes electrical contact antenna pads 34,36. In an exemplary arrangement the antenna includes six turns formed in a generally rectangular configuration, having an overall width of 4 centimeters and an overall length of 7 centimeters, for example, and having an innermost turn 38 and an outermost turn 40. An end of the innermost turn 38 is brought to a central area of the space circumscribed by the inner turn to position a first antenna contact pad 36 substantially adjacent the center of the antenna. An end portion 40 of the outermost turn is connected to the second antenna contact pad 34 by a bridging conductor 42 that extends from end portion 40 of the outer turn to the second antenna pad 34, which is closely adjacent the first antenna pad 36. To form the bridging conductor 42 a strip of dielectric material 44 (FIG. 3) is laid down over and across antenna

turns at one side of the antenna, and a pair of vias 46,48 are formed through the dielectric 44 and filled with an electrically conductive material to connect opposite ends of the bridging conductor 42 to the outer antenna turn 40 and the inner antenna pad 34.

In a typical example the 4 x 7 centimeter antenna coil is formed of conductive traces each having a width of 0.030 inches to 0.040 inches, separated by spaces of similar width, and all having a resistivity of less than about 50 milliohms per square. The antenna pads may be square, having a dimension on each side of between about 0.040 and 0.050 inches. The substrate 30 is substantially the same size as the antenna coil, being slightly larger than the outermost turn of the antenna to provide a continuous margin around the entire antenna of approximately 3 to 5 millimeters.

A double metal layer integrated circuit chip 26 containing all of the transponder circuitry is formed of a substrate 54 bearing circuitry generally indicated at 56 on a first surface (upper surface as viewed in FIG. 5). Primary chip contact pads 58,60 are connected to appropriate points of the transponder circuitry on an inner portion of the chip and project upwardly from the chip by a small distance. Preferably the pads 58,60 have a small area so as to use as small an area as possible of the chip surface. Use of small contact or connecting pads allows the circuitry to occupy larger areas of a small chip. A layer of dielectric 64 is laid down on the surface of the chip to cover and protect the circuit and to surround and encompass the pads 58,60. Dielectric 64 is formed with a pair of vias 68,70 which receive portions of a conductive material, such as aluminum, that is laid down on the upper surface (as viewed in FIG. 5) of the dielectric 64 to form secondary electrical contact chip pads 72,74. A plan view of the chip and its secondary contacts is shown in FIG. 4. The described arrangement enables the secondary metal pads 72,74 to be significantly larger than the primary pads so as to actually overlay portions of the chip circuitry (with interposed dielectric), and yet the arrangement utilizes no more of the chip area than is required for the much smaller primary pads 58,60. In an exemplary embodiment the overall size of the chip is about 0.1 inches by 0.07 inches, with each of the larger secondary pads 72,74 having a dimension of approximately 0.015 by 0.02 inches. The two secondary pads 72,74 are spaced from one another by about 0.04 inches, which is the same spacing as the spacing of the antenna pads.

The transponder chip of FIGS. 4 and 5 is mounted to the antenna by procedures illustrated in FIGS. 6 through 9 by adhesively securing the chip pads to the antenna pads, employing a suitable electrically conductive adhesive. A nonconductive structural adhesive is also used to ensure greater structural integrity.

As illustrated in FIG. 6 for example, small quantities or dots of electrically conductive adhesive 80a -

80d are deposited on the antenna pads 34,36 and small quantities or dots of a structural adhesive 86a - 86e are deposited on the substrate between and at outer sides of the antenna pads. FIG. 6 illustrates the various adhesives placed as dots onto the antenna pads prior to chip placement. If desired the adhesive can also be screen printed in place. The silicon chip 54 is then positioned over the antenna with the chip pads aligned with the antenna pads. The chip is pressed down against the substrate and its antenna. The adhesive is pressed between the pads and between the chip and substrate. It is then cured under suitable pressure and temperature to cause the electrically conductive adhesive 80 to flow over and around both the antenna pads and the chip pads and the electrically nonconductive structural adhesive 86 to flow, as shown in FIG. 7, around the edges of the chip, between the chip and the substrate, and between conductive adhesive that connects the two chip pads and the two antenna pads. The nonconductive structural adhesive 86 that is positioned between two separate portions of the conductive adhesive 80 not only provides for greater structural rigidity but further ensures electrical insulation of the two chip pads from each other and insulates the two antenna pads from each other.

The conductive adhesive can be an anisotropic or Z-axis adhesive, such as the adhesives produced by A. I. Technologies or an isotropic epoxy such as "Abelbond 967-1" or thermoplastic isotropic adhesives such as "Staystik 181". Suitable nonconductive adhesives may be those known as "Abelbond 967-3" and "Staystik 373". It is important that the electrically conductive and electrically nonconductive adhesives be compatible with regard to characteristics such as thermal expansion coefficient and mechanical response.

FIG. 7 illustrates the adhesive after placing of the chip and after application of heat and pressure. If deemed necessary or desirable, the nonconductive adhesive, which requires temperature and pressure for full curing, can be formed with a small percentage of an ultraviolet curing agent (in the order of about 5% for example) so that the structural adhesive may be partially cured by application of ultraviolet light immediately after chip placement. This allows the chip to be "tacked" into place by the ultraviolet light before it is transported to be cured or dried.

The described arrangement of adhesive bonding and the relatively large antenna and chip pads greatly ease tolerances required of antenna and chip pad positioning and also tolerances for chip positioning (relative to the antenna) for assembly of the transponder. It is not necessary for the pads of the chip and the antenna to actually be touching or even to be perfectly aligned due to the nature of the electrical conduction through the conductive adhesive. As long as there is a high percentage of overlap of a chip pad

with an antenna pad, the device will function properly. Accordingly, the described arrangement eases production tolerances and decreases production cost.

After bonding the chip to the substrate, both electrically and structurally, the chip is protected from external forces and conditions by depositing a body of ultraviolet sensitive material 90 over the chip, as shown in FIG. 8. This material is cured by application of ultraviolet light and also acts as additional structural adhesive to increase rigidity of the of the transponder in the area immediately adjacent the chip.

To provide further protection for the silicon chip and printed antenna a thin self-adhesive electrically non-conductive polyester layer or cover coat 92 may then be deposited over the entire area of the tag substrate and over the protective material 90. This provides a smooth continuous outline to facilitate passage of the RF tag through a bar code printing machine and through a suitable machine for writing into the transponder memory. The cover coat 92 also protects the antenna coil.

To facilitate securing of the RF transponder tag to the conventional paper luggage identification label, the opposite side (the bottom as viewed in FIG. 9) of the thin, transparent flexible polyester substrate 30 is provided with an adhesive layer 96 protected by a peel-off paper layer 98. Adhesive 96 may be a high performance adhesive, such as 3M adhesive 467 MIP, for example. Accordingly, to apply the RF transponder tag to the airline baggage identification label the cover paper 98 is simply removed and the tag is pressed against the baggage label, which may be done for example in the machine that prints the optical bar code.

Instead of providing for a relatively square configuration of antenna conductive pad, these pads may be of a rectangular configuration, as illustrated in FIG. 10 for pads 34a and 34b. This rectangular configuration is important for situations where the thin, flexible, transparent polyester substrate may be stretched during processing. For example, it is contemplated to manufacture a plurality of the described transponders in a continuous assembly line arrangement wherein the thin strip of polyester substrate is extracted from a large continuous roll of polyester strip material having sprocket holes for indexing and for pulling the strip from its roll. During such extraction the substrate is subject to longitudinal stretching, and thus the rectangular pad configuration is provided with the long dimension of the pad rectangle aligned with the length of the elongated strip of substrate material so that any stretching of the substrate is less likely to displace the antenna pad to a position where it would no longer be capable of registering with a pair of chip pads. The use of elongated pads allows the substrate to be stretched without adversely affecting the assembly, and thus allows the use of large reels of substrate that may be greater than 500 meters in length for use in

continuous production.

Still another alternative antenna pad construction is illustrated in FIGS. 11 and 12 in which antenna pads 34b and 36b are made in a roughly "O" shape with a strip of conductive material 35b,37b completely and continuously circumscribing an enclosed area 100,102. The enclosed area 100,102 is then filled with an electrically conductive adhesive 104,106, as shown in FIG. 12. In this arrangement the circumscribing conductive strips 35b,37b act as retaining wall for the conductive adhesive 104,106 when the latter is subject to heat and pressure and begins to flow. This arrangement allows the chip pad spacing to be reduced if necessary. FIG. 12 also shows the electrically nonconductive structural adhesive 108,110 that is applied to the substrate surface between the antenna pads, illustrating the fact that the circumscribing pad leads 35b and 37b not only constrain the electrically conductive adhesive 104,106, but also tend to constrain the electrically nonconductive structural adhesive 108,110 and prevents intermixing of the two.

An alternate antenna arrangement is illustrated in FIG. 13 where four (or some other number of) antenna turns 32a are laid down on a substrate 30a to form an inner antenna turn 38a and an outer antenna turn 40a. Again, antenna pads 34a and 36a are positioned at a central area within the inner turn 38a, but in this case a bridging conductor 42a (FIG. 14) is mounted on the opposite side of the substrate 30a. Thus the extra area of dielectric between the bridging conductor and the bridged antenna turns and one processing step is eliminated, and it is only necessary to provide vias 46a and 48a through the substrate 30a, as shown in FIG. 14, to connect to antenna pads 36a and 34a.

Although the chip is shown as being mounted within the innermost turn of the antenna and on the same side of the substrate as the antenna, it will be readily appreciated that other chip placements may be employed. Thus the chip may be placed on the same side of the substrate as the antenna but outside of the outermost turn of the antenna, or the chip may be placed anywhere on the opposite side of the substrate and have its pads connected to the antenna pads by means of conductive vias extending through the substrate.

For mass production a continuous strip of paper identification labels having a plurality of RF tags positioned on successively adjacent portions of the strip may be fan folded for ease of handling and storage. To decrease the overall thickness of such a fan folded arrangement the chip positions may be varied from one RF tag to the next so that when folded the chips of successive layers are staggered. For example, FIG. 15 is a simplified plan view of a paper identification label 110 bearing an RF tag 112 comprised of a substrate 114 which carries antenna turns (not shown in FIG. 15) and a transponder circuit chip 116. The

transponder chip is offset from a center portion of the substrate, being offset to one side as shown in FIG. 15. Alternatively, the chip may be offset toward one end or the other or may be offset both transversely and longitudinally from the center of the substrate 114. An elevational view of label 110 is shown in FIG. 16.

FIG. 17 illustrates portions of a continuous paper strip having a series of adjacent sections 120,122,124 and 126 thereof which are connected to one another along perforated lines 128,130, and 132, for example, and each of which bears a transponder 112a, 112b, 112c and 112d, respectively. Transponder chips 116a, 116b, 116c and 116d of the respective transponders are alternately displaced to one side or the other on successive transponder substrates, as shown in FIG. 17. When the overall strip 120, 122, 124, 126, etc. is fan folded, as shown in FIG. 18, the several chips are staggered and thus a more compact folding is accomplished. Each complete RF tag may be adhesively secured to any desired part of the paper identification label strip, and even may have some of the legible printing on the paper identification label printed directly over the RF tag cover layer.

It will be seen that a sprocketed flexible film can be used for the polyester dielectric substrate to enable high production volumes at low cost using the inverted "flip chip" mounting techniques described above. The inverted "flip chip" mounting technique replaces use of silicon wire bonding, which could not withstand rigors of ordinary tag use. The chip may be constructed by various known printed circuit techniques including low voltage CMOS processes employing EEPROM nonvolatile memories that are capable of storing up to 70 to 80 or more bits of digital information. The double metal layer chip pad construction enables the top surface of the chip to have only two pads separated by a relatively large distance, which may be in the order of about 0.030 inches, to enable use of epoxy type adhesives. Use of such adhesives is not possible with conventional chip pad spacings, which are in the order of 100 microns. With the chip bonding pads positioned over active circuitry on the chip, adhesive bonding is employed because wire bonding could damage underlying circuitry.

Information carried in the RF chip may be the same as or similar to the optical bar code information and also similar to some of the printed information. Redundancy of the information enables any one of several different reading systems to be used. One advantage of employing both the RF tag and the optical bar code on the same identification label is to enable such an identification label to be utilized with either optical readers or RF interrogator reading circuits.

The described transponder tag enables incorporation of an RF reading system into the baggage routing and handling system with minimum changes in airline baggage tagging procedures. The described

system, being readily incorporated into a standard paper strip identification label, is compatible with many different types of systems now in use, including bar codes, optical character recognition systems and also labels readable by the human eye.

The major portion of the described RF tag has a thickness in the order of about 150 microns, as it is formed solely by the substrate, the screen printed antenna windings and cover coat. The portion of the tag in the area of the chip includes the additional thickness of the chip and the chip protective material, and thus may have a total thickness of between about 1.5 to 2 millimeters.

Claims

1. A remotely readable identification tag comprising:
 - a flexible substrate ,
 - an antenna formed on said substrate ,
 - a transponder circuit chip ,
 - means for mounting said chip on said substrate, and
 - means for electrically connecting said chip to said antenna.
2. The apparatus of Claim 1 wherein said antenna comprises a conductive coil formed on said substrate and having first and second electrical contact antenna pads , said circuit chip including first and second electrical contact chip pads on an inner surface portion of the chip, said means for electrically connecting said chip to said antenna comprising electrically conductive adhesive interposed between said antenna pads and said chip pads.
3. The apparatus of Claim 2 wherein said antenna pads are formed on said substrate within an area thereof that is circumscribed by said antenna coil.
4. The apparatus of Claim 3 wherein said coil is comprised of a plurality of turns including an inner turn and an outer turn, said inner turn being connected to one of said antenna pads within an area circumscribed by said inner turn, and said outer turn having an end connected to a second one of said antenna pads within said area circumscribed by said inner turn.
5. The apparatus of Claim 4 including a bridging conductor extending across a plurality of said antenna turns and electrically connecting said outer turn to said second antenna pad within said inner turn.
6. The apparatus of Claim 5 wherein said flexible substrate has first and second surfaces, said antenna turns being mounted on said first surface and said bridging conductor being mounted on said second surface, and means for connecting ends of said bridging conductor through said substrate to said outer turn and to said second antenna pad.
7. The apparatus of Claim 2 wherein each said antenna pad includes an outer conductive area and an inner open area , and including conductive adhesive secured to said antenna pad and substrate within said open area.
8. The apparatus of Claim 2 including a layer of protective material extending over and secured to said chip and said antenna.
9. The apparatus of Claim 2 wherein said chip has electrical circuitry thereon and includes first and second chip primary contact pads electrically connected to said circuitry, a layer of dielectric material on said chip, and first and second chip secondary contact pads on said dielectric and electrically connected to said first and second primary pads respectively.
10. The apparatus of Claim 9 wherein said secondary pads are larger than said primary pads and overlie both said primary pads and portions of said circuitry.
11. The apparatus of Claim 2 wherein said means for mounting said chip to said substrate includes a nonconductive structural adhesive bonded to said chip between said chip pads and bonded to said substrate between said antenna pads , said structural adhesive being positioned between and electrically insulating a first portion of said conductive adhesive from a second portion of said conductive adhesive.
12. A method for forming a remotely readable identification tag comprising:
 - forming a plurality of electrically conductive antenna turns on a flexible substrate ,
 - forming first and second antenna contact pads on said turns,
 - providing a transponder circuit chip having first and second chip contact pads ,
 - bonding said first and second chip pads to said first and second antenna pads respectively, thereby bonding said chip to said antenna and substrate, and
 - forming a protective covering over said chip and antenna.
13. The method of Claim 12 wherein said step of bonding said chip pads to said antenna pads

comprises the step of interposing first and second electrically conductive adhesive portions between said chip pads and respective ones of said antenna pads.

14. The method of Claim 13 including the step of further bonding said chip to said substrate by positioning an electrically nonconductive structural adhesive between said conductive adhesive portions and between said chip and said substrate.
15. The method of Claim 12 wherein said step of forming said antenna turns includes the step of forming an inner turn and an outer turn forming said antenna contact pads within said inner turn and electrically connecting said outer turn to one of the antenna contact pads within the inner turn.
16. The method of Claim 12 wherein said step of forming antenna contact pads includes the step of forming a continuous peripheral conductor that circumscribes an open area thereof, and wherein said step of bonding comprises confining a conductive adhesive within said open area.
17. A luggage identification tag comprising:
 a flexible self-adhesive luggage identification strip configured and arranged to be secured around a luggage handle, and
 a remotely readable RF identification tag on said strip, said RF identification tag comprising:
 a flexible substrate having a first side thereof adhesively secured to said luggage identification strip,
 an antenna formed on said substrate having inner and outer turns,
 first and second antenna contact pads respectively connected with said inner and outer turns and positioned within an area circumscribed by said inner turn,
 a transponder circuit chip having first and second chip contact pads in electrical contact with respective ones of said antenna pads,
 electrically conductive adhesive encompassing said chip and antenna pads and bonded thereto,
 structural adhesive bonded to and between said chip and substrate and positioned between said chip pad and between said antenna pads, and
 a protective material covering said chip antenna and substrate.
18. The tag of Claim 17 including an optical bar code on said luggage identification strip.

19. The tag of Claim 17 wherein said chip includes circuitry on a surface thereof, said chip pads comprising relatively smaller primary pads positioned within an area encompassed by said circuitry, a layer of dielectric material on said chip covering said circuitry, and first and second relatively larger secondary pads on said dielectric and electrically connected to said primary pads.
20. A continuous multi-label strip of identification labels comprising:
 a continuous strip of flexible label material separated into a plurality of mutually adjacent sections,
 each said section comprising an independent luggage identification label, each said label comprising:
 a flexible identification label strip base,
 a flexible substrate secured to said base,
 a plurality of antenna turns formed on said substrate, and
 a transponder circuit chip secured to said substrate adjacent said antenna turns,
 the transponder chips of successive ones of said identification label sections being asymmetrically displaced in different directions from one identification label section to the next to facilitate folding and stacking of said label sections upon one another with transponder chips of mutually adjacent ones of said sections being in mutually staggered relation.

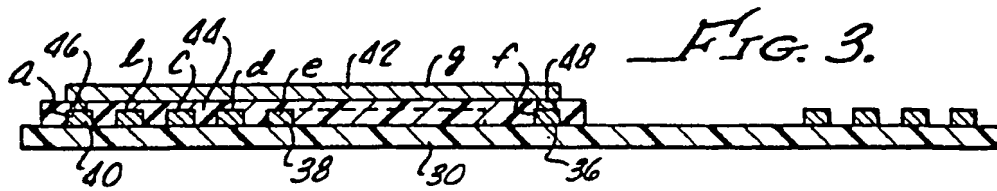
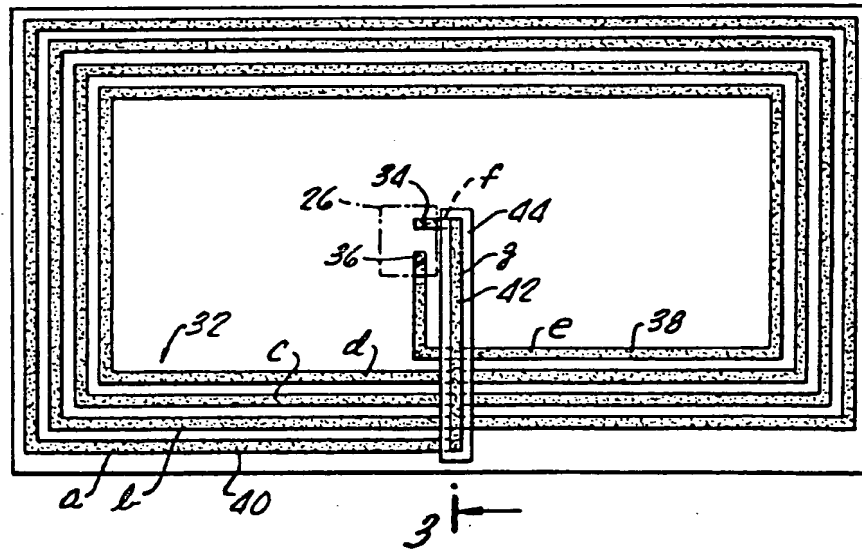
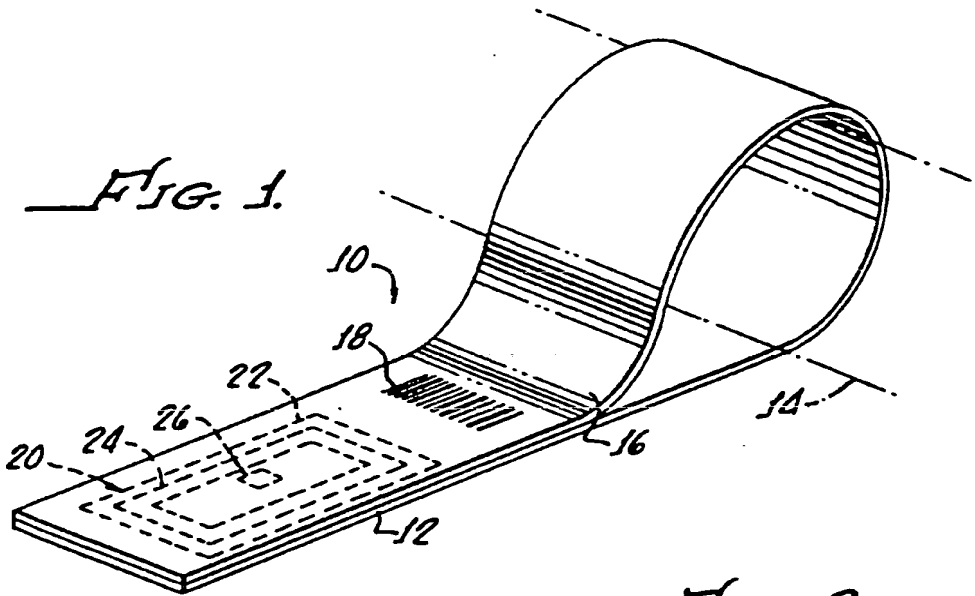

FIG. 4.

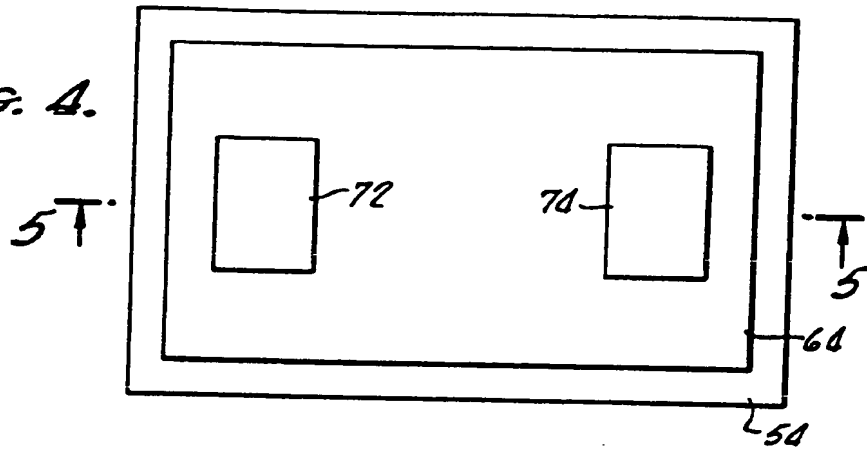

FIG. 5.

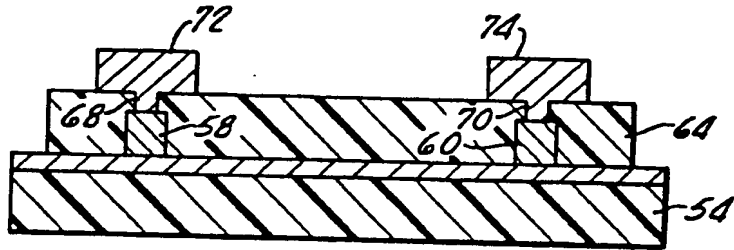

FIG. 6.

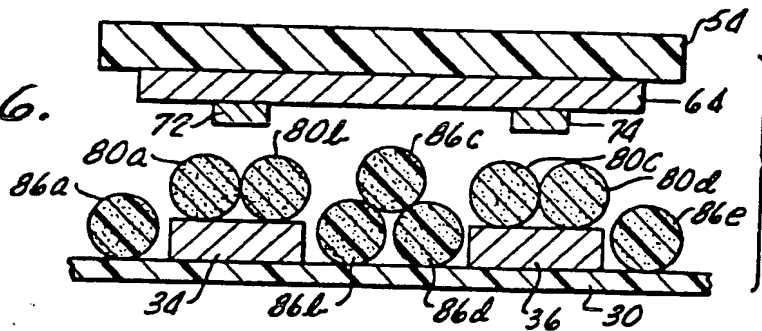
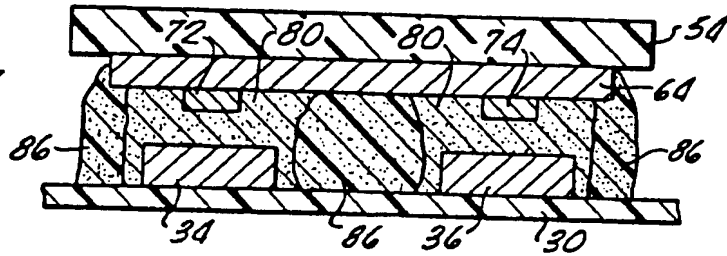

FIG. 7.



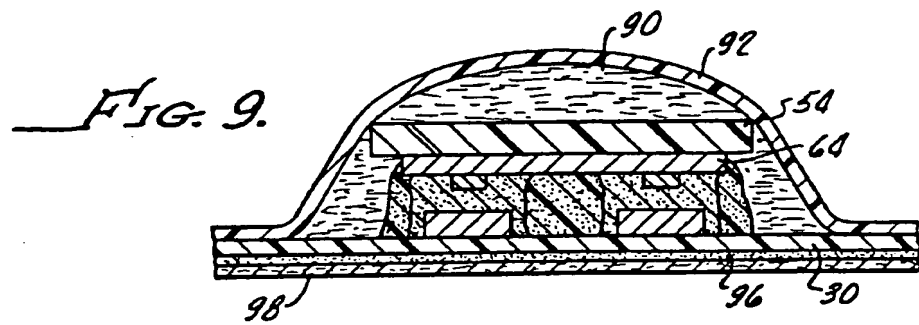
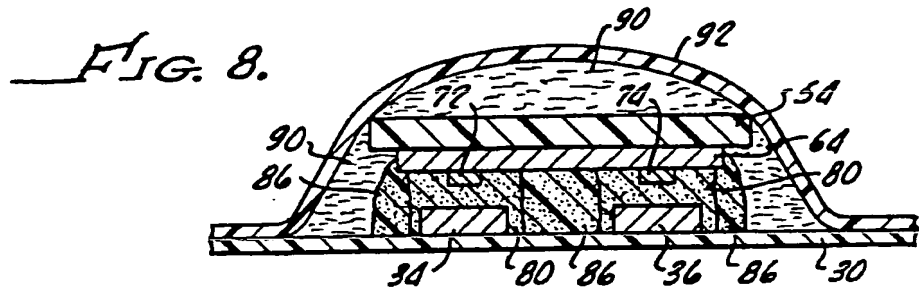

FIG. 10.

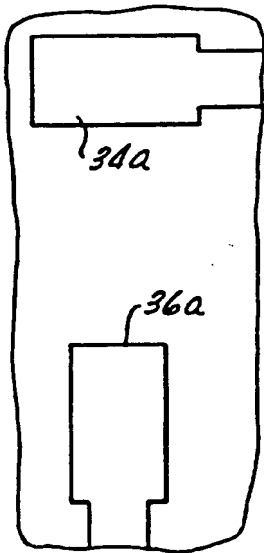

FIG. 11.

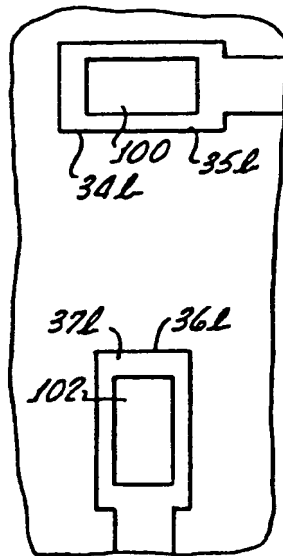
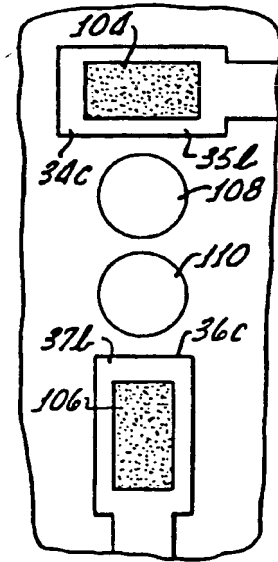
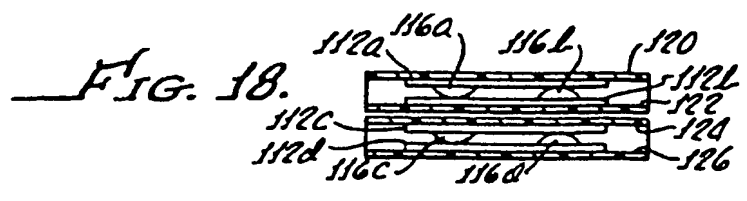
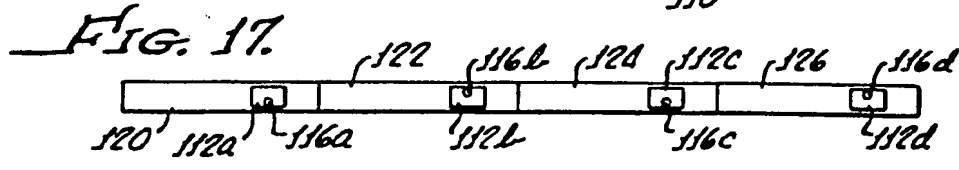
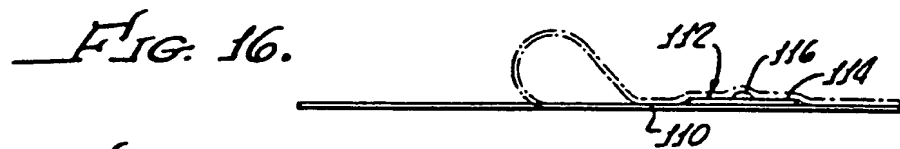
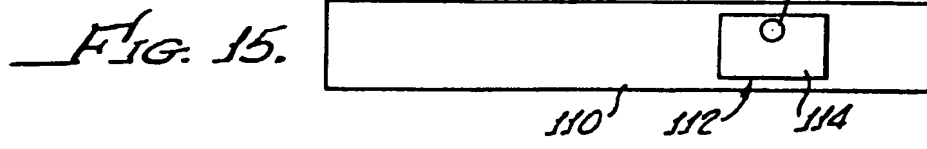
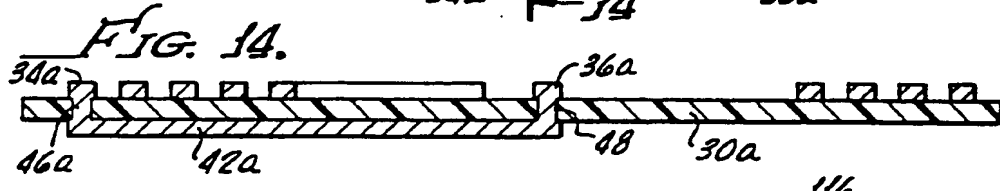
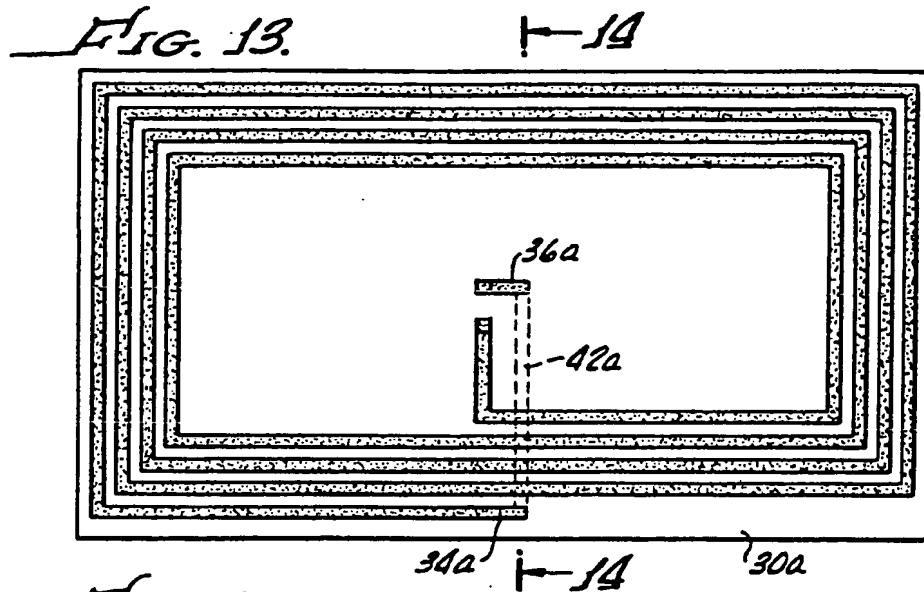

FIG. 12.





•
•
•
•
•
•